

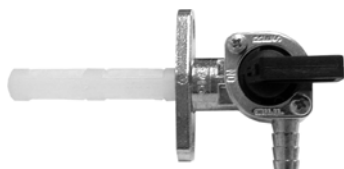

ROSCA "A"



PRESION "C"



PLATINA "B"



ELECTRICO "E"



DEPRESION "D"

REFERENCIA	MARCA	MODELO	TIPO
380 241 6006	APRILIA	AMICO LX, LX, SPORT, GL	B
380 240 6015		SR-50/125	B
380 230 6004	BETA	PRO 3	B
380 232 6007		ALP / MOTARD 4.0	B
380 231 6007	KTM	50 SPORT MINI ADVENTURE, 505X PRO JUNIOR LC, 65X, 85 SX	B
380 230 01	GAS GAS	CAMPERA	B
380 240 6134	PEUGEOT	E430, TREKKER, XFIGHT, BUXY, RS, SQUAB, ZENITH LM	D
380 240 6104		ELYSEO 125/150	D
380 240 6114		ELYSEO 50	D
380 240 6124		LOOXOR 125F	D
380 242 6004		LUDIX 10 SP	D
380 240 6144		ELYSEO 100	D
380 242 6024		VIVACITY, E 450	D
380 220 6011		LUDIX	C
380 210 61021		ZENITH, BUXY	A
380 250 61021		SPEED TT	A
380 210 60011		PGT 103	A
380 210 61011		RCXM, SPXM	A
380 210 61111		FOX SPXM, FOX VOGUE	A
380 250 61011		FOX MPRO	A
380 210 60121		RIEJU	MINIMOTO MX50, MX50 DISK
380 242 6014	RS2 NKD		D
380 220 6001	RR, RS2, MATRIX, MRX, RS2 MATRIX PRO, SMX, SPIKE, SMX PRO		C

GRIFO ROSCA

Ref.: **380 210 60011**
Rosca 12x100

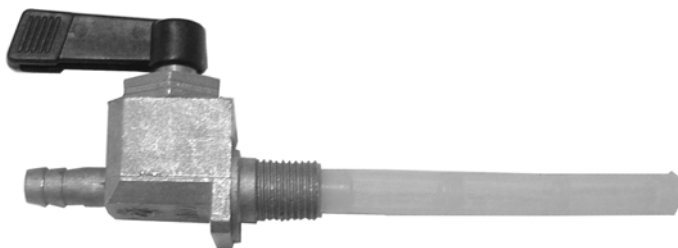

Adaptable:

- PEUGEOT PGT 103

GRIFO ROSCA

Ref.: **380 210 61011**
Rosca 12x100



Adaptable:

- PEUGEOT RCXM
SPXM

GRIFO ROSCA

Ref.: **380 210 61021**
Rosca 12x100



Adaptable:

- PEUGEOT ZENITH
BUXY

GRIFO ROSCA

Ref.: **380 250 61011**
Rosca 12x100

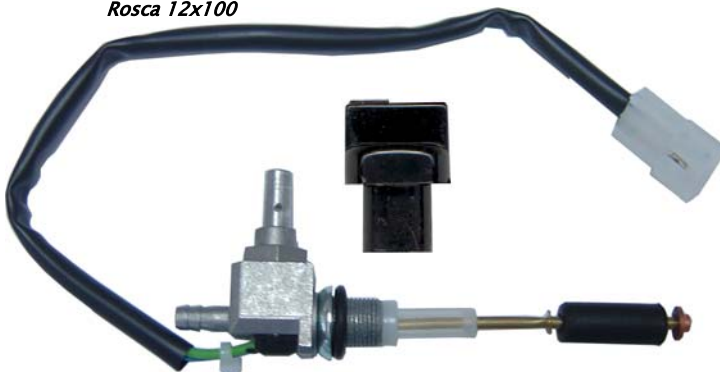

Adaptable:

- PEUGEOT FOX MPRO

GRIFO ROSCA

Ref.: **380 210 60121**
Rosca 12x100

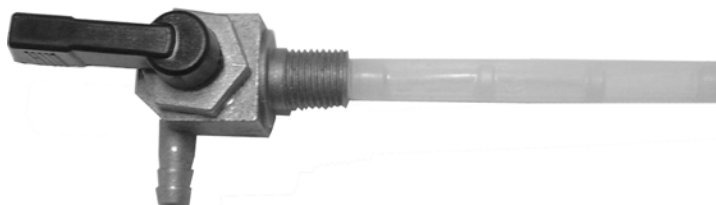

Adaptable:

- RIEJUNIMOTO MX50
MX50 DISK

GRIFO ROSCA

Ref.: **380 210 61111**
Rosca 12x100



Adaptable:

- PEUGEOT FOX SPXM
FOX VOGUE

GRIFO ROSCA

Ref.: **380 250 61021**
Rosca 12x100



Adaptable:

- PEUGEOT SPEED TT

GRIFO PLATINA

Ref.: **380 241 6006**



Adaptable:

- APRILIA AMICO LX
LX
SHORT
GL

GRIFO PLATINA

Ref.: **380 2316007**

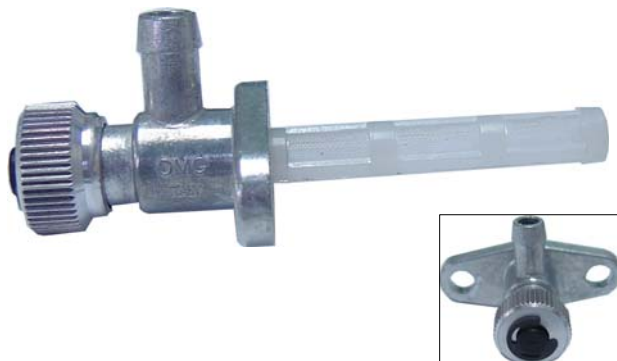

Adaptable:

- **KTM** 50 SPORT MINI ADVENTURE
505X PRO JUNIOR LC
65X

GRIFO PLATINA

Ref.: **380 232 6007**

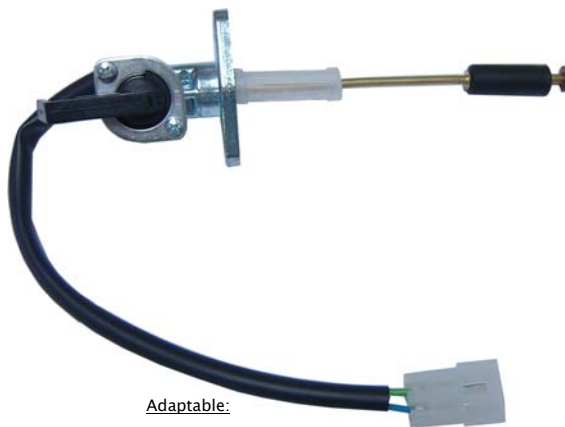

Adaptable:

- **BETAALP** MOTARD 4.0

GRIFO PLATINA

Ref.: **380 230 6004** – Doble Salida (Lateral y Posterior)

Ref.: **380 230 01** – Una Salida (Posterior)



Adaptable:

- **380 230 6004** BETA PRO 3
- **380 230 01** GAS GAS CAMPERA

GRIFO PRESIÓN

Ref.: **380 220 6001**



Adaptable:

- **RIEJURR** RS2 MATRIX / PRO , MRX
SMX
SPIKE
SMX PRO

GRIFO PRESIÓN

Ref.: **380 220 6011**

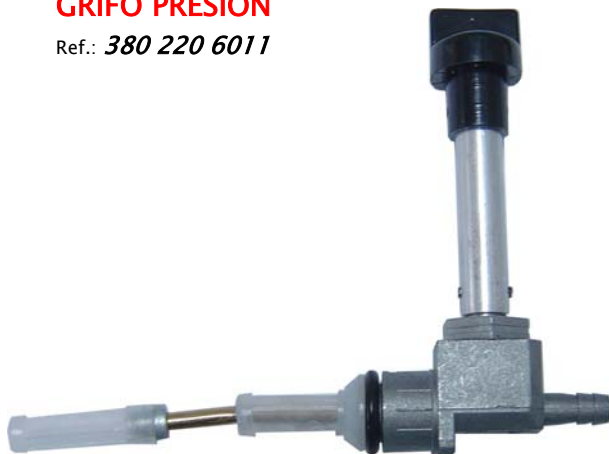

Adaptable:

- **PEUGEOT** LUDIX

GRIFO DEPRESIÓN

Ref.: **380 240 6144**

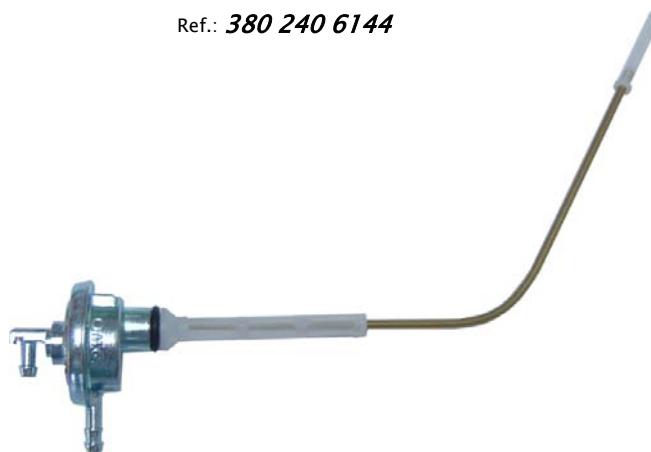

Adaptable:

- **PEUGEOT** ELYSEO 100

GRIFO DEPRESIÓN

Ref.: 380 240 6015

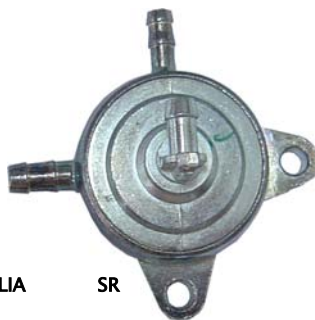

Adaptable:

- APRILIA SR

GRIFO DEPRESIÓN

Ref.: 380 240 6104



Adaptable:

- PEUGEOT ELYSEO 125/150

GRIFO DEPRESIÓN

Ref.: 380 240 6114

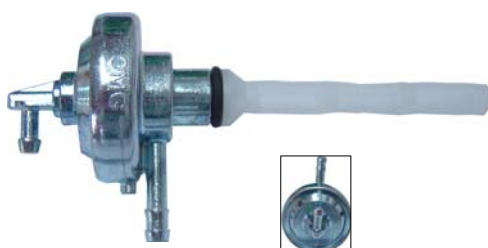

Adaptable:

- PEUGEOT ELISEO 50

GRIFO DEPRESIÓN

Ref.: 380 240 6124

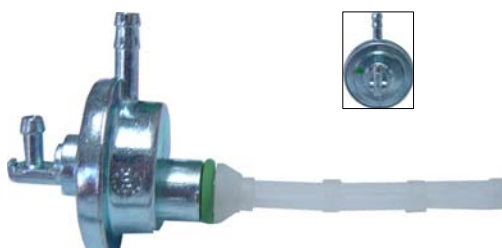

Adaptable:

- PEUGEOT LOOXOR 125 F

GRIFO DEPRESIÓN

Ref.: 380 240 6134

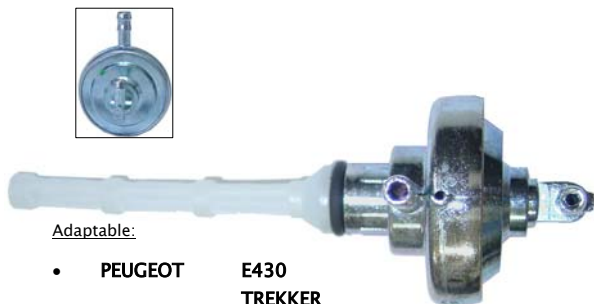

Adaptable:

- PEUGEOT E430
TREKKER
XFIGHT
BUXY
RS
SQUAB
ZENITH LM

GRIFO DEPRESIÓN

Ref.: 380 242 6004

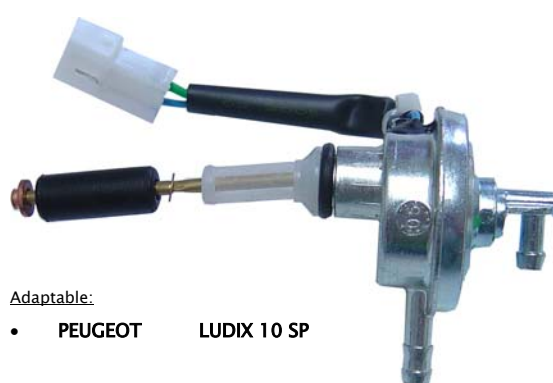

Adaptable:

- PEUGEOT LUDIX 10 SP

GRIFO ELECTRICOS

Ref.: 380 242 6014



Adaptable:

- RIEJURS2 NKD

GRIFO ELECTRICOS

Ref.: 380 242 6024



Adaptable:

- PEUGEOT VIVACITY E 450



ROSCA "A"



ELECTRICO "E"

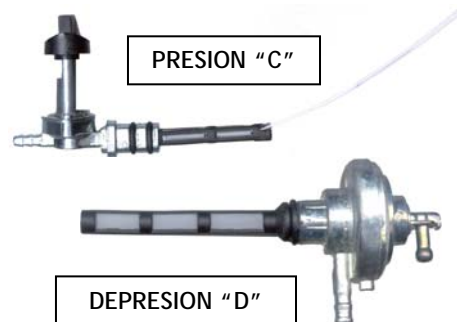

PRESION "C"

DEPRESION "D"



PLATINA "B"

REFERENCIA	MARCA	MODELO	TIPO
380 103 00	APRILIA	RS 50	A
380 130 00		RX-125 ('00-..)	B
380 130 01		RX-50 ('00-..)	B
380 130 10		RS-50 ('00-..)	B
380 110 00		SCOTTER 2 TIEMPOS (Anclaje \varnothing 15 mm)	D
380 101 04	DERBI	FDX-50 / FDT-50	A
380 104 01		VARIANT	E
380 100 00		VARIANT	C
380 120 00		DS-50	C
380 110 02		FURAX 50,AVENTURA 50,URBAN 50	D
380 110 00		SCOTTER 2 TIEMPOS (Anclaje \varnothing 15 mm)	D
380 230 01	GAS-GAS	CAMPERA	B
380 110 00	MALAGUTI	SCOTTER 2 TIEMPOS (Anclaje \varnothing 15 mm)	D
380 400 00		BOMBA DE GASOLINA ALUMNIO	-
380 402 00		BOMBA GASOLINA NYLON	-
380 101 02	M.H.E.	FURIA	A
1GF 600 00	PIAGGIO	VESPINO	A
380 102 02		VELOFAX -50	A
380 110 00		NRG / TYPHOON / ZIP / SKIPPER	D
380 400 00		BOMBA DE GASOLINA ALUMNIO	-
380 402 00		BOMBA GASOLINA NYLON	-
380 101 00	RIEJU	DRAC-50	A

1GF 620 00	UNIVERSAL	Salida inferior , Rosca 10/100	A
1GF 620 02		Salida Inferior , Rosca 12/150	
1GF 620 04		Salida Inferior , Rosca 14/125	
380 101 05		Salida Inferior , Rosca 14/150	
380 102 00		Salida Lateral Derecha , Rosca 12/150	
1GF 620 06		Salida Inferior , Rosca 16/100	
380 110 12		ESTANDARD EUROPEO SCOTTER 2 TIEMPOS (Anclaje \varnothing 15 mm)	D
380 110 14		ESTANDARD EUROPEO SCOTTER 4 TIEMPOS (Anclaje \varnothing 15 mm)	D
380 110 06		ESTÁNDAR SCOTTER 4 TIEMPOS (Anclaje \varnothing 15 mm)	D
380 190 10		GRIFO AGRÍCOLA Salida inferior	C
380 190 00		GRIFO AGRÍCOLA Salida inferior , Rosca 10/100	A
380 110 00	YAMAHA	SCOTTERS 2 TIEMPOS (Anclaje \varnothing 15 mm)	D

GRIFO ESTÁNDAR

Ref.: **1GF 620 00**
 Salida Inferior
 Rosca 10 / 100
 Caja:10 Ud.



Adaptable:

- UNIVERSAL

GRIFO ESTÁNDAR

Ref.: **1GF 620 02**
 Salida Inferior
 Rosca 12 / 150
 Caja:10 Ud.



Adaptable:

- UNIVERSAL

GRIFO ESTÁNDAR

Ref.: **1GF 620 04**
 Salida Inferior
 Rosca 14 / 125
 Caja:10 Ud.



Adaptable:

- UNIVERSAL

GRIFO ESTÁNDAR

Ref.: **380 101 05**
 Salida Inferior
 Rosca 14 / 150
 Caja:10 Ud.



Adaptable:

- UNIVERSAL

GRIFO ESTÁNDAR

Ref.: **380 101 04**
 Salida Inferior
 Rosca 14 / 125
 Caja:1 Ud.

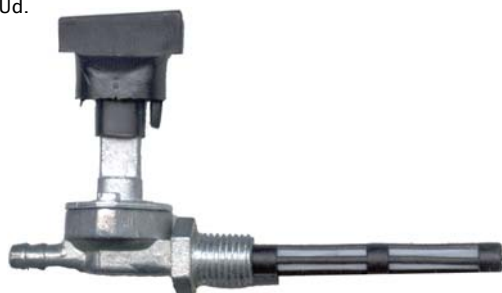

Adaptable:

- DERBI FDX 50
 FDT 50

GRIFO ESTÁNDAR

Ref.: **380 102 00**
 Salida lateral der.
 Rosca 12 / 150
 Caja:1 Ud.



Adaptable:

- CONSULTAR

GRIFO ESTÁNDAR

Ref.: **1GF 620 06**
 Salida inferior
 Rosca 16 / 100
 Caja:10 Ud.



Adaptable:

- UNIVERSAL

GRIFO ESTÁNDAR

Ref.: **380 101 02**
 Salida inferior
 Rosca 12 / 150
 Caja:1 Ud.



Adaptable:

- MHE FURIA

GRIFO ESTÁNDAR

Ref.: **1GF 600 00**
Salida Posterior
Rosca 12 / 100
Caja: 10 Ud..



Adaptable:

- PIAGGIO Vespino

GRIFO ESTÁNDAR

Ref.: **380 102 02**
Salida Lateral der.
Rosca 12 / 100
Caja: 1 Ud.



Adaptable:

- PIAGGIO VELOFAST 50

GRIFO ESTÁNDAR

Ref.: **380 103 00**
Salida LaTeral der.
Rosca 16 / 100
Caja: 1 Ud..



Adaptable:

- APRILIA RS 50

GRIFO ESTÁNDAR

Ref.: **380 101 00**
Salida Inferior
Rosca 12 / 150
Caja: 1 Ud.



Adaptable:

- RIEJU Drac 50

GRIFO ESTÁNDAR

Ref.: **380 104 01**
Salida Lateral der.
Rosca 14 / 125
Caja: 1 Ud.



Adaptable:

- DERBI Variant

GRIFO ESTÁNDAR

Ref.: **380 100 00**
Salida Inferior
Aluminio
Caja: 1 Ud.



Adaptable:

- DERBI Variant

GRIFO ROSCA

Ref.: **380 102 04**
Salida Lateral der.
Rosca 12 / 150
Caja: 1 Ud.

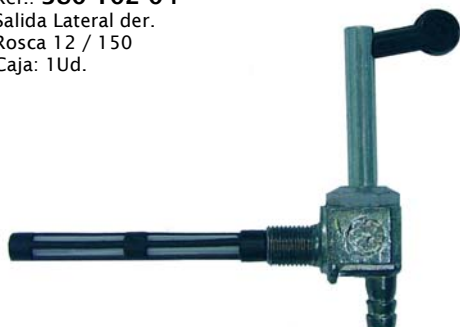

Adaptable:

- UNIVERSAL

GRIFO VESPINO

Ref.: **1GF 610 02**
Salida Lateral der.
Rosca 12 / 150
Caja: 1 Ud.



Adaptable:

- UNIVERSAL MECATECNO

GRIFO DEPRESIÓN SCOTTER (2 T.)

Ref.: 380 110 02

Con reserva
Salida Doble
Caja: 1 Ud.

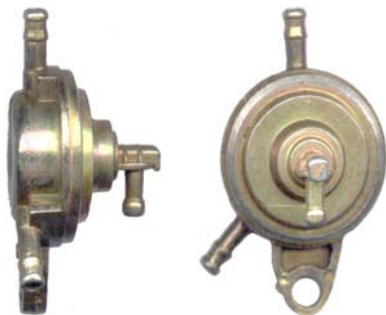

Adaptable:

- DERBI FURAX 50
AVENTURA 50
URBAN 50

GRIFO DEPRESIÓN SCOTTER (2 T.)

Ref.: 380 110 12

Salida Doble
Con reserva
Ø anclaje: 15 mm.
Caja: 1 Ud.



Adaptable:

- ESTANDAR EUROPEO SCOOTER 2 TIEMPOS
- PIAGGIO RUNNER

GRIFO DEPRESION SCOOTER (2 T.)

Ref.: 380 110 00

Salida Doble
Con reserva
Ø anclaje: 15 mm.
Caja: 1 Ud.



Adaptable:

- DERBI NRG/TYPHOON/ZIP/SKIPPER
- PIAGGIO
- YAMAHA
- MALAGUTI
- APRILIA

GRIFO PLATINA

Ref.: 380 130 01

Salida Posterior
Ø eje: 0,7 mm.
Dist. ejes: 35 mm.
Aluminio
Caja: 1 Ud.



Adaptable:

- APRILIA RX 50 ('00 - ..)



GRIFO DEPRESIÓN SCOTTER (2 T.)

Ref.: 380 110 06

Salida Doble
Con reserva
Ø anclaje: 15 mm.
Caja: 1 Ud.

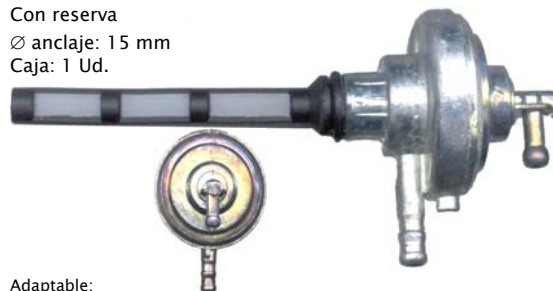

Adaptable:

- ESTANDAR SCOOTER 4 TIEMPOS

GRIFO DEPRESIÓN SCOTTER (4 T.)

Ref.: 380 110 14

Salida Doble
Con reserva
Ø anclaje: 15 mm.
Caja: 1 Ud.



Adaptable:

- ESTANDAR EUROPEO SCOOTER 4 TIEMPOS

GRIFO PLATINA

Ref.: 380 130 00

Salida Posterior
Ø eje: 0,7 mm.
Dist. ejes: 35 mm.
Aluminio
Caja: 1 Ud.



Adaptable:

- APRILIA RX 125 ('00 - ..)

GRIFO PLATINA

Ref.: 380 130 10

Salida Inferior
Ø eje: 0,7 mm.
Dist. ejes: 35 mm.
Aluminio
Caja: 1 Ud.

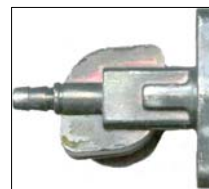

Adaptable:

- APRILIA RX 50 ('00 - ..)



GRIFO DEPRESIÓN SCOTTER (2 T.)

Ref.: 380 110 02

Con reserva
Salida Doble
Caja: 1 Ud.

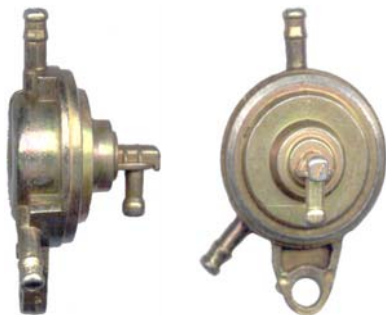

Adaptable:

- DERBI FURAX 50
AVENTURA 50
URBAN 50

GRIFO DEPRESIÓN SCOTTER (2 T.)

Ref.: 380 110 02

Salida Doble
Con reserva
Ø anclaje: 15 mm.
Caja: 1 Ud.



Adaptable:

- ESTANDAR EUROPEO SCOTTER 2 TIEMPOS
- PIAGGIO RUNNER

GRIFO DEPRESION SCOOTER (2 T.)

Ref.: 380 110 00

Salida Doble
Con reserva
Ø anclaje: 15 mm.
Caja: 1 Ud.



Adaptable:

- DERBI NRG/TYPHOON/ZIP/SKIPPER
- PIAGGIO
- YAMAHA
- MALAGUTI
- APRILIA

GRIFO PLATINA

Ref.: 380 130 01

Salida Posterior
Ø eje: 0,7 mm.
Dist. ejes: 35 mm.
Aluminio
Caja: 1 Ud.



Adaptable:

- APRILIA RX 50 ('00 - ..)



GRIFO DEPRESIÓN SCOTTER (2 T.)

Ref.: 380 110 06

Salida Doble
Con reserva
Ø anclaje: 15 mm.
Caja: 1 Ud.

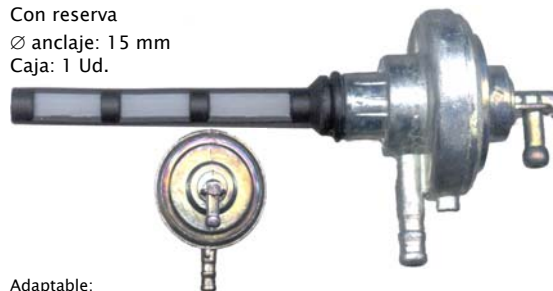

Adaptable:

- ESTANDAR SCOTTER 4 TIEMPOS

GRIFO DEPRESIÓN SCOTTER (4 T.)

Ref.: 380 110 14

Salida Doble
Con reserva
Ø anclaje: 15 mm.
Caja: 1 Ud.



Adaptable:

- ESTANDAR EUROPEO SCOTTER 4 TIEMPOS

GRIFO PLATINA

Ref.: 380 130 00

Salida Posterior
Ø eje: 0,7 mm.
Dist. ejes: 35 mm.
Aluminio
Caja: 1 Ud.



Adaptable:

- APRILIA RX 125 ('00 - ..)

GRIFO PLATINA

Ref.: 380 130 10

Salida Inferior
Ø eje: 0,7 mm.
Dist. ejes: 35 mm.
Aluminio
Caja: 1 Ud.

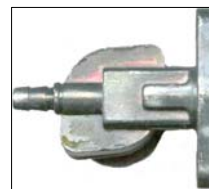

Adaptable:

- APRILIA RX 50 ('00 - ..)



FILTRO GASOLINA PEQUEÑO



FILTRO ESPECIAL DE ACEITE



REFERENCIA	CAUDALES	TELA	CARACTERÍSTICAS
1FL 000 00	∅ 6 mm.	Blanca 200 micras	Embalaje: Caja 36 unidades Adaptable: Universal
1FL 000 02	∅ 6 mm.	Negro 100 micras	

REFERENCIA	CAUDALES	TELA
1FL 000 04	4,5mm. a 2,5mm.	Blanca 200 micras

FILTRO GASOLINA PEQUEÑO



FILTRO GASOLINA MEDIANO



REFERENCIA	CAUDALES	TELA	CARACTERÍSTICAS
1FL 000 01	∅ 8 mm.	Blanca 200 micras	Embalaje: Caja 36 unidades Adaptable: Universal
1FL 000 03		Negra 100 micras	

REFERENCIA	CAUDALES	TELA	CARACTERÍSTICAS
1FL 010 00	4mm. a 4mm.	Blanca 200 micras	Embalaje: Caja 25 unidades Adaptable: Universal
1FL 010 01	4mm. a 4mm.	Negra 100 micras	